

HC-B 24-TMQ/PG29G

Order No.: 1771859



<http://eshop.phoenixcontact.de/phoenix/treeViewClick.do?UID=1771859>

Sleeve housing, with double locking latch, height 76 mm, with screw connection, 1x Pg29, straight cable entry

Commercial data

EAN	4017918036553
Pack	10 pcs.
Customs tariff	85389099
Weight/Piece	0.44246 KG
Catalog page information	Page 500 (PC-2009)

Product notes

WEEE/RoHS-compliant since:
03/01/2006



<http://www.download.phoenixcontact.com>
Please note that the data given here has been taken from the online catalog. For comprehensive information and data, please refer to the user documentation. The General Terms and Conditions of Use apply to Internet downloads.

Technical data

General data

Note	For contact inserts HC-B24, BB46, D64, DD108, M
Design	B24
Height	76 mm
Width	43 mm
Length	120 mm

Housing type	Sleeve housings
Locking type	With double locking latch
Type of the screw connection	1x Pg29
Pg screw connection	With
Wrench size, union nut	37 mm
Cable exit	Straight
External cable diameter	18 mm ... 27 mm
Degree of protection	IP65
Ambient temperature (operation)	-40 °C ... 125 °C
Housing material	Aluminum, die-cast
Housing surface material	Powder-coated, gray
Cable gland material	Nickel-plated brass
Cable seal material	NBR
Locking latch material	High-grade steel, handle: PA-GF
Material grip body interlock	PA-GF

Certificates / Approvals



Certification

GOST

Diagrams/Drawings

Dimensioned drawing

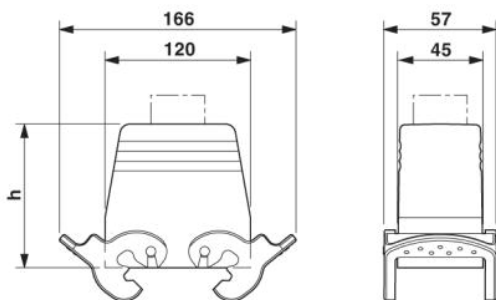

Address

PHOENIX CONTACT Inc., USA
586 Fulling Mill Road
Middletown, PA 17057, USA
Phone (800) 888-7388
Fax (717) 944-1625
<http://www.phoenixcon.com>



© 2010 Phoenix Contact
Technical modifications reserved;